

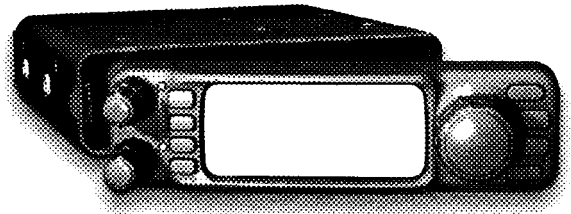

VHF/UHF DUAL BAND FM TRANSCEIVER

FT-7100M

OPERATING MANUAL



VERTEX STANDARD CO., LTD.

4-8-8 Nakameguro, Meguro-Ku, Tokyo 153-8644, Japan

VERTEX STANDARD

US Headquarters

17210 Edwards Rd., Cerritos, CA 90703, U.S.A.

International Division

8350 N.W. 52nd Terrace, Suite 201, Miami, FL 33166, U.S.A.

YAESU EUROPE B.V.

P.O. Box 75525, 1118 ZN Schiphol, The Netherlands

YAESU UK LTD.

Unit 12, Sun Valley Business Park, Winnall Close
Winchester, Hampshire, SO23 0LB, U.K.

YAESU GERMANY GmbH

Am Kronberger Hang 2, D-65824 Schwalbach, Germany

VERTEX STANDARD HK LTD.

11th Floor Tsim Sha Tsui Centre, 66 Mody Rd.,
Tsim Sha Tsui East, Kowloon, Hong Kong

Contents

Introduction	1	DTMF Autodialer Operation	28
Specifications	2	Transmitter Time-Out Timer (TOT)	30
Accessories & Option	3	Memory Operation	31
Installation	4	Memory Storage	31
Preliminary Inspection	4	Storing independent Transmit Frequencies ("Odd Splits")	31
Installation Tips	4	Recalling Memories	32
Safety Information	5	Direct Keypad Memory Recall (Requires MH-48A6J)	32
Antenna Considerations	6	Memory Offset Tuning	33
Mobile Installation	8	Masking a Memory	33
Transceiver Installation	8	Transferring Memory Channels	34
Mobile Power Connections	9	Memory only Mode	34
Mobile Speakers	9	Scanning Feature	35
Base Station Installation	10	Scanning Operation	35
AC Power Supplies	10	Scan-Resume Options	35
Packet Radio Terminal Code Controller (TNC)	10	Memory Skip Scanning	36
Front Panel Controls, Switches	12	Temporary Memory Skip	36
LCD	14	Programmable Band-Scan Limit	37
Rear Panel Connections	15	Priority Channel Operation	38
MH-48A6J Microphone	16	VFO Priority	38
MH-42B6JS Microphone	17	Memory Priority	38
Operation	18	HOME Priority	38
Basic Operation/Reception	18	Smart Search	39
Turning the Power On/Off	18	ARTS: Auto Range Transponder System .	40
Adjusting the Volume and Squelch	18	ARTS Modes	40
RF Squelch	18	CW ID (Morse identifier) Setup	41
Frequency Display and Band Change	19	Miscellaneous Settings	42
Main Dial Tuning	19	Sub-Display Options	42
Direct Keypad Frequency Entry (Requires MH-48A6J)	19	Automatic Power-Off	42
Channel Step Selection	20	Programming the microphone Button Functions	43
VFO tracking	20	DCS Code Inversion	44
Receiver Muting	21	External Speaker Selection	45
VHF-VHF (V-V) or UHF-UHF (U-U) Operation	21	Microprocessor Reset Procedures	46
Lock Feature	22	Cloning	47
Keypad Beeper	22	Menu System	48
Display Brightness	22	Menu Selection Details	50
Transmission	23		
Power Output Setting	23		
PTT Locking	23		
Repeater Splits	24		
Automatic Repeater Shift (ARS)	24		
Separate Transmit Frequency Memories	25		
Standard Repeater Shift	25		
Tone Squelch System	26		
Tone Search Scanning	27		
CTCSS Bell Paging	27		
1750 Hz Tone Calling (European Versions)	27		
DTMF Tone Generation (MH-48A6J only)	28		

INTRODUCTION

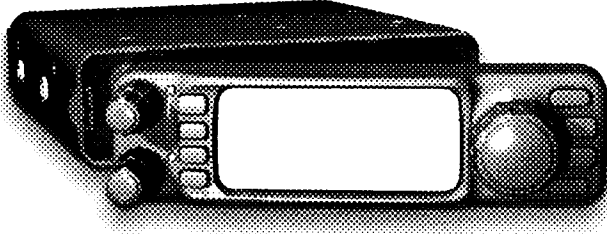

The **FT-7100M** is a ruggedly-built, high quality Dual Band FM transceiver providing 50 Watts of power output on the 144 MHz Amateur band, and 35 Watts on the 430 MHz band.

The high power output of the **FT-7100M** is produced by its 2SK3478 Power MOS FET amplifier, with a direct-flow heat sink and thermostatically-controlled cooling fan maintaining a safe temperature for the transceiver's circuitry.

Featuring 262 memory channels, dual receive with independent Volume and Squelch controls, and built-in CTCSS and DCS encoder/decoder circuits, the **FT-7100M** includes provision for remote-head mounting, utilizing the optional **YSK-7100** Separation Kit, which allows installation evening the most compact of cars.

We recommend that you read this manual in its entirety, so as to understand fully the many features of your new **FT-7100M** transceiver.

SPECIFICATIONS

General

Frequency Range:	RX: 108.00–180.00 MHz 320–480 MHz 810–999.990 MHz (Cellular Blocked)
	TX: 144–146 MHz or 144–148 MHz 430–440 MHz or 430–450 MHz
Channel Steps:	5/10/12.5/15/20/25/50 kHz
Mode of Emission:	F3, F2, F1
Antenna Impedance:	50 Ω , unbalanced (Antenna Duplexer built-in)
Frequency Stability:	± 5 ppm @ 14° F ~ +140° F (-10 °C ~ +60 °C)
Operating Temperature Range:	-4° F ~ +140° F (-20 °C ~ +60 °C)
Supply Voltage:	13.8 VDC ($\pm 15\%$), negative ground
Current Consumption (Approx.):	RX: 0.5 A (Squelched) TX: 11.5 A (VHF), 10.0 A (UHF)
Case Size (WxHxD):	5.8 x 1.9 x 6.9 inches (140 x 38 x 166 mm) (w/o knobs & connectors)
Weight (Approx.):	2.2 lb (1 kg)

Transmitter

Output Power:	50/20/10/5 W (VHF), 35/20/10/5 W (UHF)
Modulation Type:	Variable Reactance
Maximum Deviation:	± 5 kHz
Spurious Radiation:	Better than -60 dB
Modulation Distortion:	Less than 3%
Microphone Impedance:	2 k Ω
DATA Jack Impedance:	10 k Ω

Receiver

Circuit Type:	Double-conversion superheterodyne
Intermediate Frequencies:	21.7 MHz/450 kHz (VHF), 45.05 MHz/455 kHz (UHF)
Sensitivity (for 12dB SINAD):	Better than 0.16 μ V
Squelch Sensitivity:	0.1 μ V
Image Rejection:	70 dB
Selectivity (-6dB/-60dB):	12 kHz/24 kHz
Maximum AF Output:	2 W @ 8 Ω for 5% THD
AF Output Impedance:	4-16 Ω

Specifications are subject to change without notice, and are guaranteed within the 144 and 430 MHz amateur bands only.

Frequency ranges will vary according to transceiver version; check with your dealer.

ACCESSORIES & OPTION

SUPPLIED ACCESSORIES

Microphone	MH-48A6J or MH-42B6JS (depending on transceiver version) ...	1
Mobile Mounting Bracket	MMB-36	1
DC Power Cord w/Fuse	T9021715	1
Spare Fuse	15A (Q0000081)	2
Operating Manual		1
Warranty Card		1

OPTIONAL ACCESSORIES

MH-48A6J	DTMF Microphone
MH-42B6JS	Hand Microphone
YSK-7100	Separation Kit
MEK-2	Microphone Extension Kit
MMB-60	Quick Release Mobile Mounting Bracket
MMB-62	Remote Front Panel Mounting Bracket
SP-7	External Speaker
MLS-100	High-Power External Speaker
FP-1023	AC Power Supply (25A: USA only)
FP-1030A	AC Power Supply (30A)
CT-39A	Packet Interface Cable
AD-3	VHF-UHF Duplexer for Two-antenna Operation
ADMS-2	Windows™ PC Programming Software

Availability of accessories may vary. Some accessories are supplied as standard per local requirements, while others may be unavailable in some regions. Consult your Yaesu dealer for details regarding these and any newly-available options. Connection of any non-Yaesu-approved accessory, should it cause damage, may void the Limited Warranty on this apparatus.

INSTALLATION

This chapter describes the installation procedure for integrating the **FT-7100M** into a typical amateur radio station. It is presumed that you possess technical knowledge and conceptual understanding consistent with your status as a licensed radio amateur. Please take some extra time to make certain that the important safety and technical requirements detailed in this chapter are followed closely.

PRELIMINARY INSPECTION

Inspect the transceiver visually immediately upon opening the packing carton. Confirm that all controls and switches work freely, and inspect the cabinet for any damage. Gently shake the transceiver to verify that no internal components have been shaken loose due to rough handling during shipping.

If any evidence of damage is discovered, document it thoroughly and contact the shipping company (or your local dealer, if the unit was purchased over-the-counter) so as to get instructions regarding the prompt resolution of the damage situation. Be certain to save the shipping carton, especially if there are any punctures or other evidence of damage incurred during shipping; if it is necessary to return the unit for service or replacement, use the original packing materials but put the entire package inside another packing carton, so as to preserve the evidence of shipping damage for insurance purposes.

INSTALLATION TIPS

To ensure long life of the components, be certain to provide adequate ventilation around the cabinet of the **FT-7100M**.

Do not install the transceiver on top of another heat-generating device (such as a power supply or amplifier), and do not place equipment, books, or papers on top of the **FT-7100M**. Avoid heating vents and window locations that could expose the transceiver to excessive direct sunlight, especially in hot climates. The **FT-7100M** should not be used in an environment where the ambient temperature exceeds +140° F (+60° C).

SAFETY INFORMATION

The **FT-7100M** is an electrical apparatus, as well as a generator of RF (Radio Frequency) energy, and you should exercise all safety precautions as are appropriate for this type of device. These safety tips apply to any device installed in a well-designed amateur radio station.



Never allow unsupervised children to play in the vicinity of your transceiver or antenna installation.



Be certain to wrap any wire or cable splices thoroughly with insulating electrical tape, to prevent short circuits.



Do not route cables or wires through door jambs or other locations where, through wear and tear, they may become frayed and shorted to ground or to each other.



Do not stand in front of a directional antenna while you are transmitting into that antenna. Do not install a directional antenna in any location where humans or pets may be walking in the main directional lobe of the antenna's radiation pattern.



In mobile installations, it is preferable to mount your antenna on top of the roof of the vehicle, if feasible, so as to utilize the car body as a counterpoise for the antenna and raise the radiation pattern as far away from passengers as possible.



During vehicular operation when stopped (in a parking lot, for example), make it a practice to switch to Low power if there are people walking nearby.



Never wear dual-earmuff headphones while driving a vehicle.



Do not attempt to drive your vehicle while making a telephone call on an autopatch using the DTMF microphone. Pull over to the side of the road, whether dialing manually or using the auto-dial feature.

INSTALLATION

ANTENNA CONSIDERATIONS

The **FT-7100M** is designed for use with antennas presenting an impedance of near 50 Ohms at all operating frequencies. The antenna (or a 50 W dummy load) should be connected whenever the transceiver is turned on, to avoid damage that could otherwise result if transmission occurs accidentally without an antenna.

Ensure that your antenna is designed to handle 50 Watts of transmitter power. Some magnetic-mount mobile antennas, designed for use with hand-held transceivers, may not be capable of withstanding this power level. Consult the antenna manufacturer's specification sheet for details.

Most all FM work is performed using vertical polarization. When installing a directional antenna such as a Yagi or Cubical Quad, be certain to orient it so as to produce vertical polarization, unless you are engaged in a special operating situation where horizontal polarization is used. In the case of a Yagi antenna, orient the elements vertically for vertical polarization; for a Cubical Quad, the feedpoint should be at the center of one of the vertical sides of the driven element (or at a side corner, in the case of a diamond-shaped Cubical Quad).

Note that this transceiver is designed with wide frequency coverage in the VHF/UHF spectrum. For general listening, you may wish to have a broadband antenna such as a discone available, as a directional antenna such as a Yagi will have degraded performance outside the Amateur band for which it is designed.

Excellent reference texts and computer software are available for the design and optimization of VHF and UHF antennas. Your dealer should be able to assist you with all aspects of your antenna installation requirements.

Use high-quality 50 Ohm coaxial cable for the lead-in to your **FT-7100M** transceiver. All efforts at providing an efficient antenna system will be wasted if poor quality, lossy coaxial cable is used. Losses in coaxial lines increase as the frequency increases, so an 8-meter-long (25') coaxial line with 1/2 dB of loss at 28 MHz may have a loss of 6 dB or more at 446 MHz; choose your coaxial cable carefully based on the installation location (mobile vs. base) and the overall length of the cable required (for *very short* runs of cable in a mobile installation, the smaller, more flexible cable types may be acceptable).

ANTENNA CONSIDERATIONS

For reference, the chart below shows approximate loss figures for typically-available coaxial cables frequently used in VHF/UHF installations.

Loss in dB per 30 m (100 feet) for Selected 50-Ohm Coaxial Cables

(Assumes 50-ohm Input/Output Terminations)

CABLE TYPE	Loss: 144 MHz	Loss: 430 MHz
RG-58A	6.5	> 10
RG-58 Foam	4.7	8
RG-213	3.0	5.9
RG-8 Foam	2.0	3.7
Belden 9913	1.5	2.9
Times Microwave LMR-400	1.5	2.6
7/8" "Hardline"	0.7	1.3

Loss figures are approximate; consult cable manufacturers' catalogs for complete specifications.

In outdoor installations, be certain to weatherproof all connectors thoroughly, as water entering a coaxial cable will cause losses to escalate rapidly, thus diminishing your communications effectiveness. The use of the shortest possible length of the highest quality coaxial cable that fits within your budget will ensure the best performance from your **FT-7100M**.

INSTALLATION

MOBILE INSTALLATION

The **FT-7100M** must only be installed in vehicles having a 13.8 Volt negative ground electrical system. Mount the transceiver where the display, controls, and microphone are easily accessible, using the supplied **MMB-36** mounting bracket.

The transceiver may be installed in almost any location, but should not be positioned near a heating vent nor anywhere where it might interfere with driving (either visually or mechanically). Make sure to provide plenty of space on all sides of the transceiver so that air can flow freely around the radio's case. Refer to the diagrams showing proper installation procedures.

Transceiver Installation

- ❑ Choose a mounting location with sufficient clearance for the transceiver. Using the mounting bracket as a template for the mounting holes, use a 4.8 mm (3/16") bit to drill the mounting holes, and secure the mounting bracket with the supplied screws, washers, and nuts (see diagram).
- ❑ Position the transceiver in the bracket so that the holes in the side are aligned with those in the bracket, and bolt the transceiver into place using the supplied short screws and flat washers.

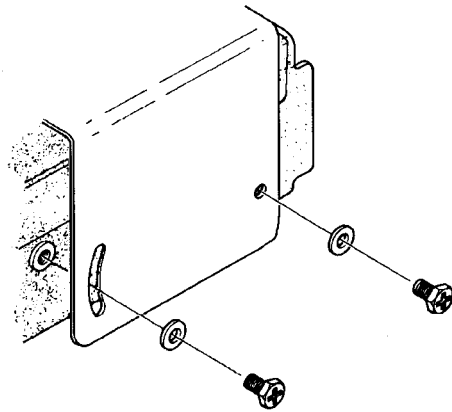
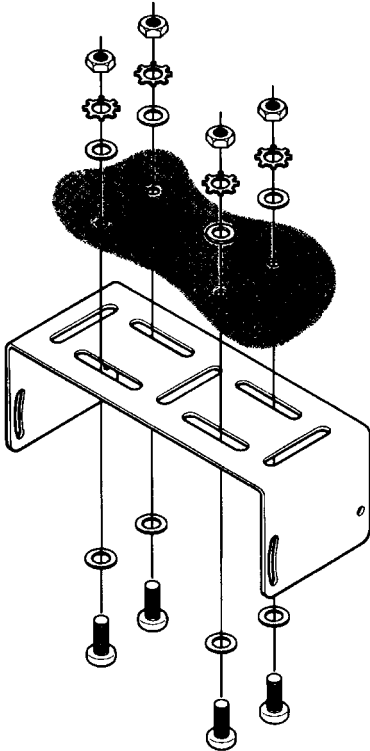

INSTALLATION

MOBILE INSTALLATION

Mobile Power Connections

To minimize voltage drop and avoid blowing the vehicle's fuses, connect the supplied DC power cable directly to the battery terminals. *Do not attempt to defeat or bypass the DC cable's fuse – it is there to protect you, your transceiver, and your vehicle's electrical system.*

Warning!

Never apply AC power to the power cable of the FT-7100M, nor DC voltage greater than 15.8 Volts. When replacing the fuse, only use a 15-A fast-blow type. Failure to observe these safety precautions will void the Limited Warranty on this product.

- ❑ Before connecting the transceiver, check the voltage at the battery terminals while revving the engine. If the voltage exceeds 15 Volts, adjust the vehicle's voltage regulator before proceeding with installation.
- ❑ Connect the **RED** power cable lead to the **POSITIVE (+)** battery terminal, and the **BLACK** power cable lead to the **NEGATIVE (-)** terminal. If you need to extend the power cable, use #12 AWG or larger insulated, stranded copper wire. Solder the splice connections carefully, and wrap the connections thoroughly with insulating electrical tape.
- ❑ Before connecting the cable to the transceiver, verify the voltage and polarity of the voltage *at the transceiver end of the DC cable* using a DC voltmeter. Now connect the transceiver to the DC cable.

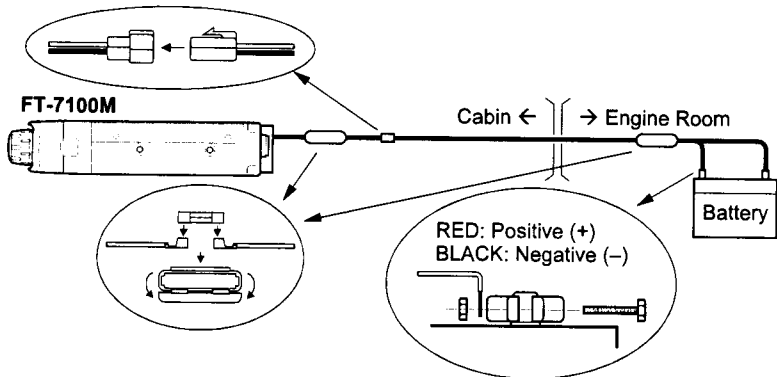

Mobile Speakers

The optional **SP-7** External Speaker includes its own swivel-type mounting bracket, and is available from your Yaesu dealer.

Other external speakers may be used with the **FT-7100M**, if they present the specified 8-Ohm impedance and are capable of handling the 2 Watts of audio output supplied by the **FT-7100M**.

INSTALLATION

BASE STATION INSTALLATION

The **FT-7100M** is ideal for base station use as well as in mobile installations. The **FT-7100M** is specifically designed to integrate into your station easily, using the information to follow as a reference.

AC Power Supplies

Operation of the **FT-7100M** from an AC line requires a power source capable of providing at least 15 Amps continuously at 13.8 Volts DC. The **FP-1023** and **FP-1030A** AC Power Supplies are available from your Yaesu dealer to satisfy these requirements. Other well-regulated power supplies may be used, as well, if they meet the above voltage and current specifications.

Use the DC power cable supplied with your transceiver for making power connections to the power supply. Connect the **RED** power cable lead to the **POSITIVE (+)** power supply terminal, and connect the **BLACK** power cable lead to the **NEGATIVE (-)** power supply terminal.

Packet Radio Terminal Node Controller (TNC)

The **FT-7100M** provides a convenient rear-panel **DATA** jack for easy connections to your TNC. This connector is a standard mini-DIN connector. A pre-wired connector and cable assembly option, model **CT-39A**, is available from your local Yaesu dealer.

The **FT-7100M**'s **DATA** jack connections are optimized for the data transmission and reception speed in use. In accordance with industry standards, the signal levels, impedances, and bandwidths are significantly different on 9600 bps as opposed to 1200 bps. If your TNC does not provide multiple lines to accommodate such optimization, you may still be able to utilize your TNC, if it is designed for multiple-radio use, by connecting the TNC "Radio 1" port to the 1200 bps lines on the **FT-7100M**, and the "Radio 2" port to the 9600 bps lines.

The pin connections of the Data connector are shown below.

DATA Jack Pin Out

Pin	Label	Note	CT-39A Wire Color
1	PKD	Packet Data Input <i>Impedance: 10 kΩ, Maximum Input Level: 40 mV p-p for 1200 bps 2.0 Vp-p for 9600 bps</i>	Brown
2	GND	Signal Ground	Red
3	PTT	Ground to Transmit	Orange
4	RX9600	9600 bps Packet Data Output <i>Impedance: 10 kΩ, Maximum Output: 500 mV p-p</i>	Yellow
5	RX1200	1200 bps Packet Data Output <i>Impedance: 10 kΩ, Maximum Output: 300 mV p-p</i>	Green
6	SQL	Squelch Control <i>Squelch Open: +5 V, Squelch Close: 0 V</i>	Blue

INSTALLATION

BASE STATION INSTALLATION

Note that 9600 bps packet transmit-deviation adjustment is very critical to successful operation, and can only be accomplished using a calibrated deviation meter (such as that found on an FM Service Monitor used in a communications service center). In most cases, the Packet Data Input level (set via a potentiometer inside the TNC) must be adjusted to provide a deviation of ± 2.75 kHz (± 0.25 kHz). Check with your packet node's sysop if you have any questions about the appropriate deviation level for your network. Note also that high throughput on 9600 bps frequently requires strong signals, so you may wish to consider the use of a directional antenna such as a Yagi for communication with high-speed packet nodes.

The setting of the 1200 bps Packet Data Input level is much less critical than it is at 9600 bps, and satisfactory adjustment to the optimum ($\pm 2.5 \sim \pm 3.5$ kHz) deviation can usually be done "by ear" by adjusting the TNC's 1200 bps TX Audio Level potentiometer so that the outgoing packets (as monitored on a separate VHF or UHF receiver) are approximately the same level as (A) the DTMF tones or (B) the 1750 Hz Burst tone produced using the microphone.

Typical connections to a TNC are shown below.

Finally, note that the ("PCKT") MENU selection allows you to set the Packet data rate (1200 or 9600 bps) independently for each band. If you have trouble getting your **FT-7100M** to respond correctly during packet operation, check to be certain that you do not have Menu #19 (PCKT) set to the wrong data rate.

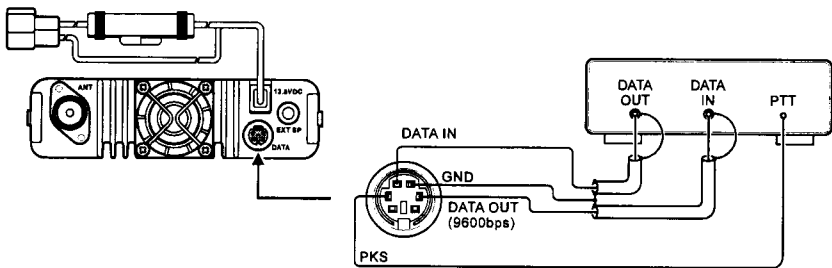

9600 bps Packet Setup

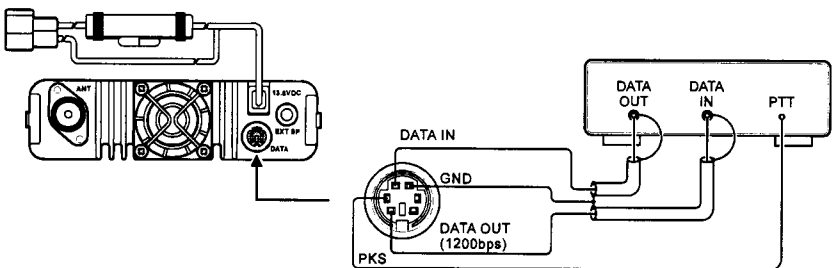

1200 bps Packet Setup

FRONT PANEL CONTROLS, SWITCHES

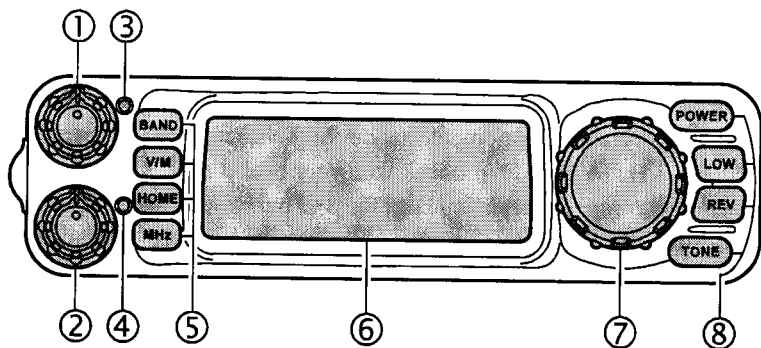

① VOL - SQL (“main” band) Controls

The inner **VOL** control adjusts the speaker audio level from the “main” band receiver (default: VHF is the *upper* band on the display). Clockwise rotation increases the audio level.

The outer **SQL** control is used to silence background noise on the “main” band receiver. It should be advanced clockwise just to the point where the noise is silenced (and the green “main” **BUSY/TX** Indicator turns off), so as to provide the best sensitivity to weak signals.

② VOL - SQL (“sub” band) Controls

The inner **VOL** control adjusts the speaker audio level from the “sub” band receiver (default: UHF is the *lower* band on the display). Clockwise rotation increases the audio level.

The outer **SQL** control is used to silence background noise on the “sub” band receiver. It should be advanced clockwise just to the point where the noise is silenced (and the green “sub” **BUSY** Indicator turns off), so as to provide the best sensitivity to weak signals.

③ BUSY/TX Indicator (“main” band)

This dual-color LED glows Green when a signal is being received on the “main” band channel. This LED glows Red when you are transmitting.

④ BUSY Indicator (“sub” band)

This LED glows Green when a signal is being received on the “sub” band channel.

⑤ Command Keys

These four keys select many of the most important operating features on the **FT-7100M**.

[BAND] Key: Pressing this key switches “main” band control between the VHF band and UHF band. Press and hold in this key for 1/2 second to activate the “Menu” mode.

LCD

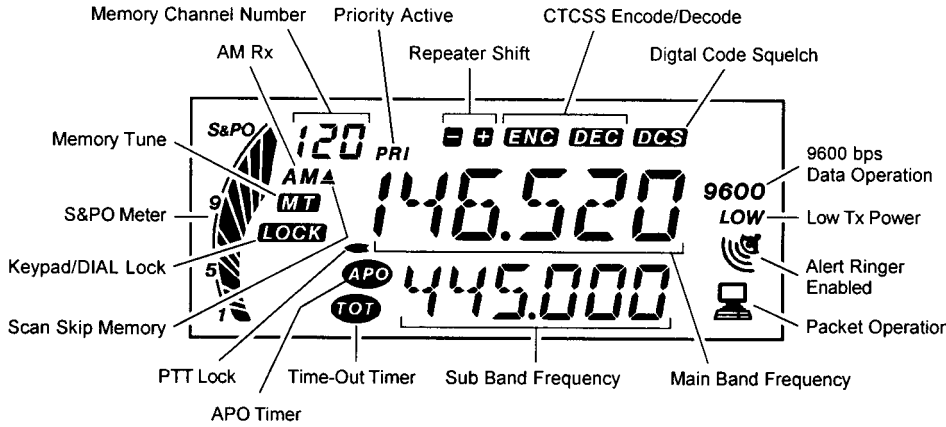

REAR PANEL CONNECTIONS

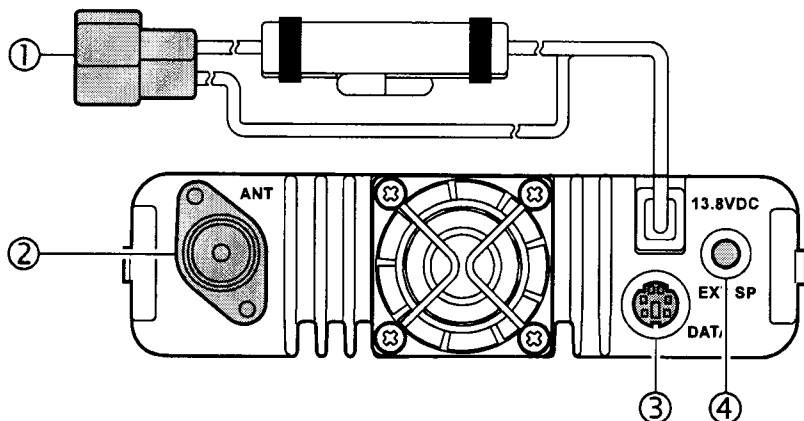

① 13.8V DC $\overline{\text{---}}$ Cable Pigtail w/Fuse

This is the DC power supply connections for the transceiver. Use the supplied DC cable to connect this pigtail to the car battery or base station DC power supply (capable of at least 15 Amperes, continuous duty). Make certain that the RED lead connects to the Positive side of the power source, and BLACK lead connects to the Negative side of the power source.

② ANT Jack

Connect a dual-band antenna's 50 Ω cable to this **M**-type (SO-239) coaxial connector. European versions are equipped with a Type-**N** connector. Be certain to use the proper type of plug for connection of the coaxial cable.

③ DATA Jack

This 6-pin mini-DIN connector provides simple interfacing to a packet Terminal Node Controller (TNC) for 1200 bps or 9600 bps operation. The pinout is detailed on page 10.

④ EXT SP Jack

This 2-conductor, 3.5-mm mini phone jack provides audio output for an optional speaker (impedance is 4 ~ 16 Ω). Inserting a plug into this jack disables audio from the internal speaker.

MH-48A6J MICROPHONE

① PTT Switch

Press this switch to transmit, and release it to receive.

② Keypad

These 16 keys generate DTMF tones during transmission.

In the receive mode, these 16 keys can be used for direct frequency entry and/or direct numeric recall of the Memory channels.

③ [P1]/[P2]/[P3]/[P4] Buttons

[P1] button: This button replicates the functions of the transceiver's **[BAND]** key. In the European version, press this button to transmit a 1750 Hz Burst Tone for repeater access.

[P2] button: This button replicates the functions of the transceiver's **[V/M]** key.

[P3] button: This button replicates the functions of the transceiver's **[TONE]** key.

[P4] button: This button replicates the functions of the transceiver **[LOW]** key.

You can reprogram the **[P1]**, **[P2]**, **[P3]**, and **[P4]** buttons for other functions, if desired. See page 43.

④ LAMP Switch

This switch illuminates the **MH-48A6J** keypad.

⑤ LOCK Switch

This switch locks out the **MH-48A6J** buttons (except keypad and **PTT** switch).

⑥ UP/DWN Button

Press (or hold in) either of these buttons to tune (or scan up or down) the band or through the memory channels. In many ways, these buttons emulate the function of the (rotary) **Main Dial** knob.

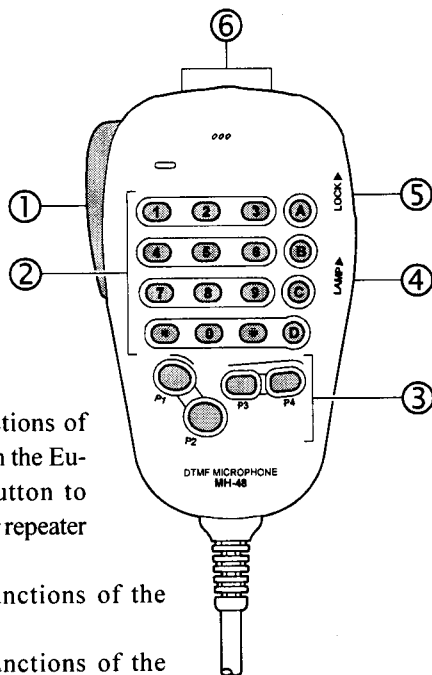

MH-42B6JS MICROPHONE

The **MH-42B6JS** is similar to the **MH-48A6J**, but the **MH-42B6JS** does not include a DTMF keypad and its illumination switch.

① PTT Switch

Press this switch to transmit, and release it to receive.

② [ACC]/[P]/[P1]/[P2] Buttons

[ACC] button: This button replicates the functions of the transceiver's **[BAND]** key. In the European version, press this button to transmit a 1750 Hz Burst Tone for repeater access.

[P] button: This button replicates the functions of the transceiver's **[V/M]** key.

[P1] button: This button replicates the functions of the transceiver's **[TONE]** key.

[P2] button: This button replicates the functions of the transceiver **[LOW]** key.

You can reprogram the **[ACC]**, **[P]**, **[P1]**, and **[P2]** buttons for other functions, if desired. See page 43.

③ LOCK Switch

This switch locks out the **MH-42B6JS** buttons (except **PTT** switch).

④ UP/DWN Button

Press (or hold in) either of these buttons to tune (or scan up or down) the band or through the memory channels. In many ways, these buttons emulate the function of the (rotary) **Main Dial** knob.

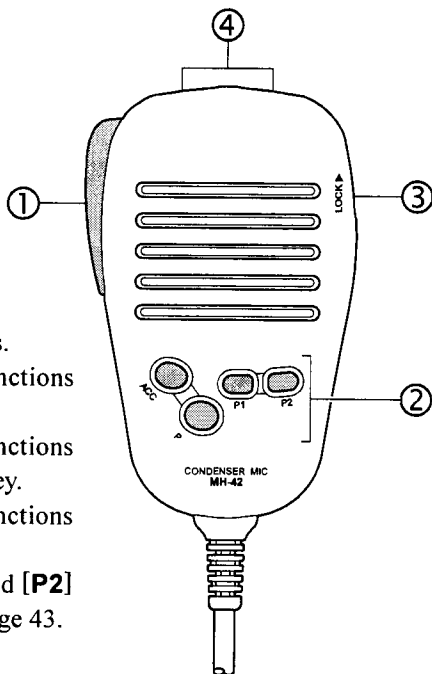

Notice

If you replace the microphone from the **MH-48A6J** to **MH-42B6JS** or vice versa, perform Menu # 17 (MIC). See page 52 for details.

OPERATION

BASIC OPERATION/RECEPTION

Turning the Power On/Off

To turn the radio on, press and hold in the **PWR** switch for 1/2 second.

To turn the radio off, again press and hold in the **PWR** switch for 1/2 second.

Adjusting the Volume and Squelch

Volume and Squelch are set independently for the “main” and “sub” bands of the transceiver.

The *upper* **VOL** and **SQL** controls provide adjustment for the *upper* display side (**MAIN** Band) of the **FT-7100M**, while the *lower* **VOL** and **SQL** controls provide adjustment for the *Lower* display side (**SUB** Band).

Advance the setting of the appropriate **VOL** control for a comfortable listening level on the back-ground noise or signals present on the band of interest.

When no signal is present, advance the **SQL** control of each band just to the point where the background noise is just silenced. The Green **BUSY** indicator for the current band will disappear when the background noise is silenced.

Do not advance the setting of the **SQL** control too far, as you will only be able to hear very strong local signals if the squelch is set too “tight.” Leaving the squelch just past the threshold of noise silencing results in the best sensitivity.

RF Squelch

A special *RF Squelch* feature is provided on the **FT-7100M**. This feature allows you to set the squelch so that only signals exceeding a certain S-meter level will open the squelch. To set up the RF Squelch circuit for operation, use the following procedure:

1. Press and hold in the [**BAND**] key for 1/2 second to activate the “Menu” mode.
2. Rotate the **Main Dial** knob to select Menu # 24 (**RF SQL**).
3. Press the [**BAND**] key momentarily to enable changing of this Menu item.
4. Rotate the **Main Dial** knob to select the desired signal strength level for the squelch threshold (**S-1**, **S-5**, **S-9**, or **S-FULL**). The default setting is **OFF**.
5. Press and hold in the [**BAND**] key for 1/2 second to save the new setting and exit to normal operation.
6. Finally, rotate the **SQL** control to the 3-o’clock position.

This adjustment can be set independently for each band.

BASIC OPERATION/RECEPTION

Frequency Display and Band Change

If the transceiver has not been used before, the display will look something like this:

We call the *upper* frequency the “main” band, and the *lower* frequency the “sub” band. Transmission is possible only on the “main” band, but you can select both bands to receive different frequencies *on the same band* (V-V or U-U operation, described later).

To change the “main” band between VHF and UHF, simply press the **[BAND]** key momentarily (default: “main” band is VHF, “sub” band is UHF).

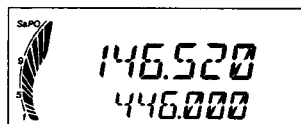

USA Version

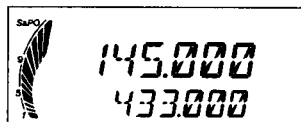

European Version

Main Dial Tuning

This mode is used for choosing a frequency within the “main” band.

In the “VFO” mode, the **Main Dial** knob and microphone **[UP]**/**[DWN]** buttons allow the Variable Frequency Oscillator (VFO) to tune in the selected step size. When scanning in the VFO mode, the same step sizes are used as in manual tuning.

To select the 1 MHz range in which you wish to operate, press the **[MHz]** key momentarily, then rotate the **Main Dial** knob. All the “MHz” digits of the frequency display will blink while “1 MHz Tuning” is enabled. Press the **[MHz]** key again (momentarily), then rotate the **Main Dial** knob to tune around the “main” band in the normal synthesizer step.

To select the 10 MHz range in which you wish to operate (if you are making a major frequency change, for example), press and hold in the **[MHz]** key for 1/2 second, then rotate the **Main Dial** knob. The 10 MHz and 100 MHz digits of the frequency display will blink while “10 MHz Tuning” is enabled. Press and hold in the **[MHz]** key again (for more than 1/2 second), then rotate the **Main Dial** knob to tune around the “main” band in the normal synthesizer step.

Direct Keypad Frequency Entry (Requires MH-48A6J)

The desired operating frequency may be entered directly from the microphone’s keypad.

To enter a frequency from the keypad, just press the numbered digits on the keypad in the proper sequence. To round all digits to the right of the current digit to “0,” press the **[#]** key.

Example:

To enter 146.520 MHz, press **[1]** → **[4]** → **[6]** → **[5]** → **[2]** → **[0]**.

To enter 433.000 MHz, press **[4]** → **[3]** → **[3]** → **[#]**.

OPERATION

BASIC OPERATION/RECEPTION

Channel Step Selection

Tuning steps are factory preset to default increments which are appropriate for the country to which this radio is exported. Different steps may be present for VHF and UHF, as well, if appropriate for your area. For example, on the U.S. version, the default steps for VHF are 5 kHz, while on UHF the default steps are 25 kHz.

To change to another step size, use the following procedure:

1. Press and hold in the **[BAND]** key for 1/2 second to activate the “Menu” mode.
2. Rotate the **Main Dial** knob to select Menu # 27 (STEP).
3. Press the **[BAND]** key momentarily to enable changing of this Menu item.
4. Rotate the **Main Dial** knob to select a desired step size. The available steps are 5.0/10.0/12.5/15.0/20.0/25.0/50.0 (kHz/step).
5. Press and hold in the **[BAND]** key for 1/2 second to save the new setting and exit to normal operation.

The step size can be set independently for each band. Just change the frequency band on the “main” display field before entering Menu #27, then use the above procedure.

VFO Tracking

The “main” and “sub” VFOs may be “slaved” together, so that rotation of the **Main Dial** knob (or stepping of the microphone **[UP]/[DWN]** buttons) causes *both* VFOs to move in tandem. Each VFO will increment in the step sizes that have been established by you previously, i.e. one step on VHF might be 5 kHz and one step on UHF might be 25 kHz, and VFOs will advance by those increments during VFO Tracking operation.

To activate VFO tracking, use the following procedure:

1. Press and hold in the **[BAND]** key for 1/2 second to activate the “Menu” mode.
2. Rotate the **Main Dial** knob to select Menu # 33 (VFOTR).
3. Press the **[BAND]** key momentarily to enable changing of this Menu item.
4. Rotate the **Main Dial** knob to select “ON.”
5. Press and hold in the **[BAND]** key for 1/2 second to save the new setting and exit to normal operation.

To disable the VFO tracking function, select “OFF” in step 4 above.

BASIC OPERATION/RECEPTION

Receiver Muting

The Mute feature is useful in situations where it would be helpful to reduce the audio level of the “sub” receiver whenever you receive a signal on the “main” band.

To activate the Mute feature:

1. Press and hold in the [BAND] key for 1/2 second to activate the “Menu” mode.
2. Rotate the **Main Dial** knob to select Menu # 18 (MUTE).
3. Press the [BAND] key momentarily to enable changing of this Menu item.
4. Rotate the **Main Dial** knob to select “AUTO.”
5. Press and hold in the [BAND] key for 1/2 second to save the new setting and exit to normal operation.

To disable the Mute feature, select “OFF” in step 4 above.

VHF-VHF (V-V) or UHF-UHF (U-U) Operation

The **FT-7100M** typically operates on one VHF and one UHF frequency. However, the **FT-7100M** may be configured to operate either in a V-V or U-U mode, if needed. Operation in either of these modes is easily enabled:

- If the “main” band is VHF, press and hold in the [HOME] key for 1/2 second. The transceiver will now display replicate its VHF frequency on both *upper* and *lower* channels, and will be operating in the “V-V” mode.
- If the “main” band is UHF, press and hold in the [HOME] key for 1/2 second. The transceiver will now replicate its UHF frequency on both *upper* and *lower* channels, and will be operating in the “U-U” mode.
- To return to “normal” VHF-UHF operation, press and hold in the [HOME] key for 1/2 second. The original VFO or Memory frequency for the “sub” band will be restored.

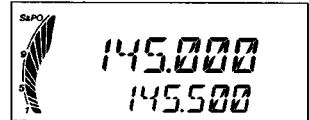

VHF-VHF (V-V) Operation

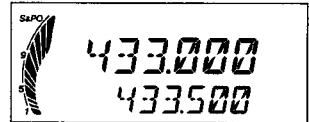

UHF-UHF (U-U) Operation

During V-V or U-U operation, receive sensitivity and intermodulation rejection of the “sub” receiver will be degraded slightly. However, this usually will not be noticeable except during operation in highly RF-congested areas.

OPERATION

BASIC OPERATION/RECEPTION

Lock Feature

The Lock function prevents accidental changes to the frequency setting and the key/button controls.

1. Press and hold in the [BAND] key for 1/2 second to activate the “Menu” mode.
2. Rotate the **Main Dial** knob to select Menu # 15 (LOCK).
3. Press the [BAND] key momentarily to enable changing of this Menu item.
4. Rotate the **Main Dial** knob one click to change the display to “ON.”
5. Press and hold in the [BAND] key for 1/2 second to save the new setting and exit to normal operation.

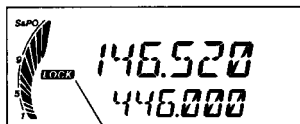

Lock Feature Active

To *unlock* the keys and buttons for normal operation, select “OFF” in step 4 above.

Keypad Beeper

The key/button beeper provides useful audible feedback whenever a key or button is pressed.

If you want to turn the beeper off (or back on again):

1. Press and hold in the [BAND] key for 1/2 second to activate the “Menu” mode.
2. Rotate the **Main Dial** knob to select Menu # 4 (BEEP).
3. Press the [BAND] key momentarily to enable changing of this Menu item.
4. Rotate the **Main Dial** knob to select “OFF.”
5. Press and hold in the [BAND] key for 1/2 second to save the new setting and exit to normal operation.

Display Brightness

The orange display illumination has been specially engineered to provide high visibility over a wide range of ambient lighting situations.

The brightness of the display is manually adjustable, using the following procedure:

1. Press and hold in the [BAND] key for 1/2 second to activate the “Menu” mode.
2. Rotate the **Main Dial** knob to select Menu # 7 (DIM).
3. Press the [BAND] key momentarily to enable changing of this Menu item.
4. Rotate the **Main Dial** knob to select a comfortable brightness level (DIM 1 ~ DIM 7, or OFF).
5. Press and hold in the [BAND] key for 1/2 second to save the new setting and exit to normal operation.

TRANSMISSION

To transmit, simply close the **PTT** (Push To Talk) switch on the microphone when the frequency is clear. Hold the microphone approximately 25 mm (1") from your mouth, and speak into the microphone in a normal voice level. When your transmission is complete, release the **PTT** switch; the transceiver will revert to the receive mode.

During transmission, the "main" band **BUSY/TX** indicator changes from Green to Red, and the S&PO meter segments rise up according to the power output selected.

Power Output Setting

Four power output levels are available on this transceiver: 5 watts (LOW), 10 watts (MID 2), 20 watts (MID 1) and 50 watts (VHF) or 35 watts (UHF) on HIGH.

To change the power level, press the [**LOW**] key. Each time you press the [**LOW**] key, the new power level will be displayed for a few seconds, then the regular display mode will reappear.

The power level can be set independently for each band. Also, the power level may be stored in a memory register, if desired.

PTT Locking

The **PTT** circuitry may be locked out, so as to prevent unauthorized or otherwise undesired transmission.

To lock out the **PTT** circuitry and thus prevent transmission:

1. Press and hold in the [**BAND**] key for 1/2 second to activate the "Menu" mode.
2. Rotate the **Main Dial** knob to select Menu # 16 (LOCKT).
3. Press the [**BAND**] key momentarily to enable changing of this Menu item.
4. Rotate the **Main Dial** knob to select the desired lock mode:
 - BAND A:** **PTT** will be disabled on VHF only;
 - BAND B:** **PTT** will be disabled on UHF only;
 - BOTH:** **PTT** will be disabled on both the VHF and UHF bands; or
 - OFF:** **PTT** lock feature is off.
5. Press and hold in the [**BAND**] key for 1/2 second to save the new setting and exit to normal operation.

To cancel the **PTT** lock feature, select "OFF" in step 4 above.

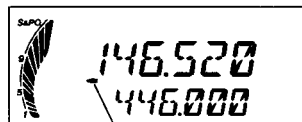

PTT Lock Active

OPERATION

TRANSMISSION

Repeater Splits

This transceiver offers three methods of setting up split frequency operation on repeaters:

- Automatic Repeater Shift (ARS), providing automatic activation of repeater shifts during designated repeater frequency subbands;
- Independently stored transmit and receive frequencies (typically not corresponding to established repeater frequency shifts); and
- Manual selection of preset repeater shifts.

Automatic Repeater Shift (ARS)

The ARS (Automatic Repeater Shift) feature in the **FT-7100M** allows easy and convenient repeater operation by automatically activating the repeater shift function whenever you tune within a standard repeater sub-band. The ARS function is preset at the factory to conform to the band-plans for the country to which it is exported.

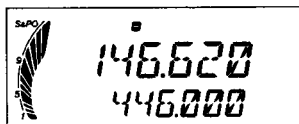

The ARS function is enabled at the factory. To disable it:

1. Press and hold the **[BAND]** key for 1/2 second to activate the “Menu” mode.
2. Rotate the **Main Dial** knob to select Menu # 2 (ARS).
3. Press the **[BAND]** key momentarily to enable changing of this Menu item.
4. Rotate the **Main Dial** knob one click to change the display to “OFF.”
5. Press and hold the **[BAND]** key for 1/2 second to save the new setting and exit to normal operation.

To enable the ARS function again, select “ON” in step 4 above.

The ARS function can be set independently for each band. And if you need to change the default repeater shift (if the bandplan in your country should change, for example), the default shift may be changed via Menu #26 (see page 53).

TRANSMISSION

Separate Transmit Frequency Memories

All memory channels can store independent receive and transmit frequencies; this allows the radio to accommodate occasional non-standard offsets with greater frequency resolution than is available using the “standard” shift feature.

Here is the procedure for storing an “odd split” frequency pair into a memory. A full discussion of memory channel storage and recall is found in the “Memory Operation” section.

1. First store the receive (repeater output) frequency. In the VFO mode, turn the transceiver to the desired receive frequency. Now, press and hold in the [V/M] key for 1/2 second.
2. Within five seconds of pressing the [V/M] key, use the **Main Dial** knob (or the microphone’s [UP]/[DWN] buttons) to select the memory channel number on which you wish to store the frequency pair.
3. Now press and hold in the [V/M] key again, to store the receive frequency into the selected memory.
4. Next, store the transmit (repeater input) frequency. Since you are still in the VFO mode, just tune the transceiver to the desired transmit frequency.
5. Now, press and hold in the [V/M] key for 1/2 second.
6. Within five seconds of pressing the [V/M] key, use the **Main Dial** knob (or the microphone’s [UP]/[DWN] buttons) to select the *same* memory channel number as used in step 2 above.
7. Press and hold in the **PTT** switch, then press and hold in the [V/M] key for 1/2 second while holding the **PTT** switch. This will not cause transmission, but rather it will instruct the transceiver that you are programming a separate transmit frequency into a memory.

When an “odd split” memory is recalled, when you press the **PTT** switch you will observe the display changing to indicate the repeater’s uplink frequency. Note also that the display shows the “**⊕**” icon on the display; this indicates that an “odd” (non-standard) shift has been stored on this channel.

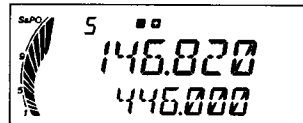

Standard Repeater Shifts

If you may assign the “Repeater Shift” feature to one of the microphone’s programming buttons (such as [P1]), you may activate the “standard” repeater shift by pressing the programmable button assigned to this function. See page 43 for details regarding of the microphone button’s functions.

OPERATION

TRANSMISSION

Tone Squelch System

These systems allow silent monitoring until a call directed to you is received, and can offer listening privacy on an otherwise busy channel.

- **CTCSS** (Continuous Tone Coded Squelch System): This system superimposes a continuous, subaudible (low-frequency) tone on your transmitted audio. When decoded at the other station, this allows their squelch to open so as to receive your transmission. Some “closed” repeaters use this to limit access, or to prevent signals intended for other repeaters (with the same input frequency) in fringe areas from locking up the repeater. There are 50 selectable CTCSS tones.
- **DCS** (Digital Code Squelch): DCS operation modulates a subaudible tone according to a digital protocol (continuous 32-bit synchronous code). DCS is widely used in the commercial land-mobile industry because of its superior performance, and its 104 unique codes offer greater tone selection than CTCSS.

To use either CTCSS or DCS, both stations must be on the same operating frequency, and must have selected the same CTCSS tone or DCS code.

Select and activate CTCSS or DCS operation

1. Pressing the **[TONE]** key to select the desired tone control mode from the following:

- “**ENC**” (Encode) appears when the CTCSS tone generator is activated for *transmission* only.
- “**ENC/DEC**” (Encode & Decode) appears when the CTCSS tone squelch is activated for both TX & RX (only signals “encoded” with the matching tone will open the squelch; your radio will remain silent otherwise).
- “” (CTCSS Bell Paging) appears when CTCSS Bell Paging is activated, as described in detail later.
- “**DCS**” (Digital Code Squelch) appears when Digital Code Squelch system (TX & RX) is active.
- “**OFF**” (Tone or digital code system is disabled).

2. Within three seconds of releasing the **[TONE]** key, use the **Main Dial** knob (or the microphone’s **[UP]**/**[DWN]** buttons) to select the tone *frequency* (when “ENC,” “ENC/DEC,” or “” is activated) or *DCS code* (when “DCS” is activated).
3. Wait a few seconds: the display will revert to its normal status, and your new CTCSS or DCS information will be saved.

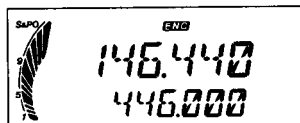

CTCSS Tone Generator

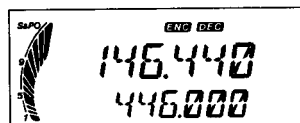

CTCSS Tone Squelch

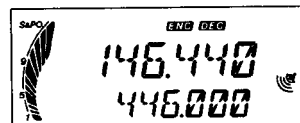

CTCSS Bell Paging

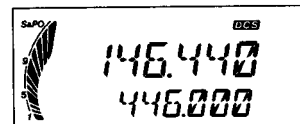

DSC Code Squelch

TRANSMISSION

Tone Search Scanning

In operating situations where you don't know the CTCSS or DCS code being used by another station or stations, you can command the radio to listen to the incoming signal and scan in search of the tone being used.

To scan for the tone in use:

1. Set the radio up for either CTCSS or DCS Decoder operation (see the previous discussion). In the case of CTCSS, "ENC/DEC" will appear on the display; in the case of DCS, "DCS" will appear on the display.
2. Press and hold the **[BAND]** key for 1/2 second, then rotate the **Main Dial** knob to select Menu # 30 (TSRCH) for CTCSS tone search or Menu # 9 (DCS S) for DCS code search.
3. Press the **[BAND]** key to start scanning for the incoming CTCSS or DCS tone/code.
4. When the radio detects the correct tone or code, it will halt on that tone/code, and audio will be allowed to pass. Press the **[BAND]** key to lock in that tone/code and exit to normal operation.

CTCSS Bell Paging

Bell Paging adds an alert ringer to CTCSS tone squelch operation, for added convenience. When you receive a call with a matching CTCSS tone, the ringer sounds to alert you to the presence of the incoming call.

To activate CTCSS Bell operation, press the **[TONE]** key until "🔔" appears on the display.

As before, calls without a matching CTCSS tone will be ignored. Those *with* a matching tone will cause the transceiver to ring as the squelch opens while the caller transmits. Note that other stations do not need to have the CTCSS *Bell* function to call you; they can just use standard CTCSS encoding.

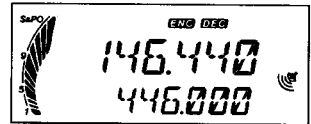

When you reply to a CTCSS Bell call, you may want to turn off the Bell function, or else the transceiver will ring every time your squelch opens.

You can store CTCSS Bell Paging as a "tone mode" in a memory, as you can do with different CTCSS/DCS tone and encode/decode status.

1750 Hz Tone Calling (European Versions)

In the European versions of the **FT-7100M**, press the **[P1]** (**MH-48A6J**) or **[ACC]** (**MH-42B6JS**) button on the microphone to transmit a 1750 Hz Burst Tone for repeater access.

If you own a non-European version of the **FT-7100M**, but plan on visiting a country which requires a 1750 tone for repeater access, you may use menu #20 to set up the **[P1]** (**MH-48A6J**) or **[ACC]** (**MH-42B6JS**) button for 1750 Hz Tone operation. See page 43 for details.

OPERATION

TRANSMISSION

DTMF Tone Generation (MH-48A6J only)

The white keys (with numbers, letters, or the */# characters printed on them) on the microphone may be used for manual sending of DTMF tones for autopatch or repeater control use. Just press the **PTT** switch, and hold it in, while pressing the desired keys.

DTMF Autodialer Operation

Sixteen DTMF Autodialer memories are available on the **FT-7100M**. These DTMF Autodialer memories can store up to 16 digits of a telephone number for repeater autopatch or other use.

To load DTMF Autodialer memories, use following procedure:

1. Press and hold the **[BAND]** key for 1/2 second to activate the "Menu" mode.
2. Rotate the **Main Dial** knob to select Menu # 14 (DTMFW).
3. Press the **[BAND]** key momentarily to enable changing of this Menu item.
4. Rotate the **Main Dial** knob to select the DTMF Autodialer memory channel number into which you wish store a telephone number ("CH-01" ~ "CH-16").
5. Press the **[BAND]** key momentarily.
6. Use the **Main Dial** knob (or the microphone's **[UP]/[DWN]** buttons) to select the first digits of the telephone number you wish to store.
7. When you have selected the correct digit, press the **[LOW]** key momentarily.
8. Now, use the **Main Dial** knob (or the microphone's **[UP]/[DWN]** buttons) to select the second of 16 available digits in the current DTMF Autodialer memory. Press the **[LOW]** key momentarily.
9. Repeat this procedure for each digit in the telephone number.
10. If you mistake an error during programming, you may press the **[REV]** key *momentarily* as a backspace key. If you wish to erase all digits before the current one, *press and hold in* the **[REV]** key for 1/2 second. You may now press the **[TONE]** key momentarily to review your entry for accuracy.
11. When entry of all digits is complete, press the **[BAND]** key. This locks the DTMF string into the current register.
12. Use the **Main Dial** knob (or the microphone's **[UP]/[DWN]** buttons) to select another DTMF Autodialer memory channel, and repeat the process described above, beginning in step 4. When you are done programming all desired DTMF Autodialer memory channels, press and hold in the **[BAND]** key for 1/2 second to exit to normal operation.

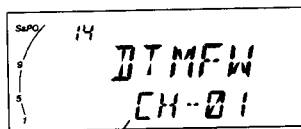

DTMF Autodialer Memory

DTMF Autodialer Memory
Current Digit

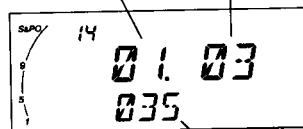

Telephone Number

TRANSMISSION

Tone Search Scanning

In operating situations where you don't know the CTCSS or DCS code being used by another station or stations, you can command the radio to listen to the incoming signal and scan in search of the tone being used.

To scan for the tone in use:

1. Set the radio up for either CTCSS or DCS Decoder operation (see the previous discussion). In the case of CTCSS, "ENC/DEC" will appear on the display; in the case of DCS, "DCS" will appear on the display.
2. Press and hold the [BAND] key for 1/2 second, then rotate the **Main Dial** knob to select Menu # 30 (TSRCH) for CTCSS tone search or Menu # 9 (DCS S) for DCS code search.
3. Press the [BAND] key to start scanning for the incoming CTCSS or DCS tone/code.
4. When the radio detects the correct tone or code, it will halt on that tone/code, and audio will be allowed to pass. Press the [BAND] key to lock in that tone/code and exit to normal operation.

CTCSS Bell Paging

Bell Paging adds an alert ringer to CTCSS tone squelch operation, for added convenience. When you receive a call with a matching CTCSS tone, the ringer sounds to alert you to the presence of the incoming call.

To activate CTCSS Bell operation, press the [TONE] key until "📞" appears on the display.

As before, calls without a matching CTCSS tone will be ignored. Those *with* a matching tone will cause the transceiver to ring as the squelch opens while the caller transmits. Note that other stations do not need to have the CTCSS *Bell* function to call you; they can just use standard CTCSS encoding.

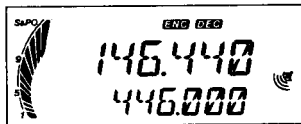

When you reply to a CTCSS Bell call, you may want to turn off the Bell function, or else the transceiver will ring every time your squelch opens.

You can store CTCSS Bell Paging as a "tone mode" in a memory, as you can do with different CTCSS/DCS tone and encode/decode status.

1750 Hz Tone Calling (European Versions)

In the European versions of the **FT-7100M**, press the [P1] (**MH-48A6J**) or [ACC] (**MH-42B6JS**) button on the microphone to transmit a 1750 Hz Burst Tone for repeater access.

If you own a non-European version of the **FT-7100M**, but plan on visiting a country which requires a 1750 tone for repeater access, you may use menu #20 to set up the [P1] (**MH-48A6J**) or [ACC] (**MH-42B6JS**) button for 1750 Hz Tone operation. See page 43 for details.

OPERATION

TRANSMISSION

Transmitter Time-Out Timer (TOT)

The “Time-Out Timer” (TOT) feature is designed to force the transceiver into the “receive” mode after a preset time period of continuous transmission (the default is 6 minutes). This feature prevents your transceiver from transmitting a “dead carrier” for a long period of time in the event that the microphone **PTT** switch is accidentally locked in the “TX” condition.

The Time-Out Timer’s “switch-to-receive” time may be adjusted, in one minute increments, for any period between 1 and 30 minutes. To change the default (6 minutes) time setting:

1. Press and hold in the [**BAND**] key for 1/2 second to activate the “Menu” mode.
2. Rotate the **Main Dial** knob to select Menu # 31 (TOT).
3. Press the [**BAND**] key momentarily to enable changing of this Menu item.
4. Rotate the **Main Dial** knob to select the desired time interval (between 1 and 60 minutes, or “OFF.”)
5. Press and hold in the [**BAND**] key for 1/2 second to save the new setting and exit to normal operation.

When the TOT feature is activated, “**TOT**” appears at the bottom of the display, and a timer starts every time you press the **PTT** switch. About a minute before the selected time-out period has expired (during transmission), “**TOT**” will begin blinking. Then, if you continue pressing the **PTT** switch until the selected **TOT time interval**, transmission will cease, and you will hear the alert beeper sound until you release the **PTT** switch.

MEMORY OPERATION

MEMORY STORAGE

1. Select the desired frequency, while operating in the VFO mode. Be sure to set up any CTCSS or DCS tones as well as any desired repeater offset. The power level may also be set at this time, if you wish to store it at a particular level of interest.
2. Press and hold in the [V/M] key for 1/2 second.
3. Within the three seconds of releasing the [V/M] key, use the **Main Dial** knob (or the microphone's [UP]/[DWN] buttons) to select the desired memory channel. The memory channel number will be blinking on the LCD.
4. To attach an alpha/numeric name (label) to the memory, press the [V/M] key *momentarily*; otherwise *press and hold in* the [V/M] key for 1/2 second to save the entry and exit.
5. To label a memory with an alpha/numeric name, use the **Main Dial** knob (or the microphone's [UP]/[DWN] buttons) to select any of the 80 available characters (including letters, numbers, and special symbols). When the desired first character appears, press the [LOW] key momentarily to move on to the next character.
6. Select succeeding characters in the same manner, pressing the [LOW] key momentarily after each selection.
7. You may move to the back character by pressing the [BAND] key momentarily. Press and hold the [BAND] key for 1/2 second to erase the characters at the right.
8. After entering the entire name (five characters maximum for upper display field, six for lower field), press and hold in the [V/M] key for 1/2 second to save all data for the channel and exit.

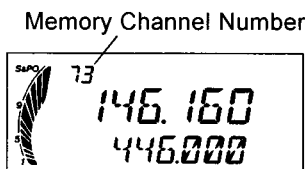

Storing Independent Transmit Frequencies (“Odd Splits”)

All memories can store an independent transmit frequency, for operation on repeaters with non-standard shifts. Both frequencies must be inside the same amateur band. To do this:

1. Store the receiving frequency (and label the channel with an alpha/numeric name, if desired) using the method already described under “**Memory Storage**” (it does not matter if a repeater offset is active).
2. Tune to the desired transmit frequency, then press and hold in the [V/M] key for 1/2 second.
3. Within the three seconds of releasing the [V/M] key, rotate the **Main Dial** knob (or press the microphone's [UP]/[DWN] buttons) to select the same memory channel number as used in step 1 above.
4. Press and hold in the **PTT** switch; while holding it in, press and hold in the [V/M] key for 1/2 second once more (this does not key the transmitter).

MEMORY OPERATION

RECALLING MEMORIES

From the VFO mode, momentarily press the [V/M] key to activate the “Memory” mode.

When more than one memory has been stored, use the **Main Dial** knob to select a memory for operation. Alternatively, the microphone’s [UP]/[DWN] buttons may be used to select or scan through the available memories. When using the microphone’s [UP]/[DWN] buttons, press the button momentarily to move one step up or down; press and hold the [UP] or [DWN] button for 1/2 second to begin memory scanning.

When you recall a memory which contains independently-stored transmit and receive frequencies, the “**+**” indication will appear in the display.

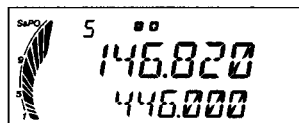

“Odd Split” memory

If you recall a memory which includes an alpha/numeric name, press and hold in the [LOW] key for 1/2 second to display the alpha/numeric tag. Repeatedly pressing and holding in the [LOW] key will toggle operation between the “**F**requency” display and “**T**ag” display options.

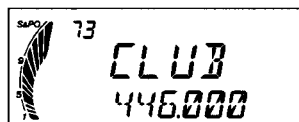

“Tag” Display

To return to the VFO mode, just press the [V/M] key again.

Direct Keypad Memory Recall (Requires MH-48A6J)

The desired memory channel may be recalled directly from the microphone’s keypad.

To recall a memory channel from the keypad, just press the digits on the keypad in the proper sequence, followed by the [*] key.

Example:

To recall memory channel #5, press [5] → [*].

To recall memory channel #100, press [1] → [0] → [0] → [*].

MEMORY OPERATION

RECALLING MEMORIES

Memory Offset Tuning

Once you have recalled a particular memory channel, you may easily tune off that channel, as though you were in the “VFO” mode.

1. With the **FT-7100M** in the “MR” (Memory Recall) mode, select the desired memory channel.
2. Now press the **[MHz]** key momentarily; the “**MT**” icon will appear on the display.
3. Rotate the **Main Dial** knob (or press the microphone’s **[UP]/[DWN]** buttons), as desired, to tune to a new frequency. The synthesizer steps selected for VFO operation on the current band will be the steps used during Memory Tuning.
4. If you wish to return to the *original* memory frequency, press the **[V/M]** key momentarily. The “**MT**” icon will disappear.
5. If you wish to store the new frequency set during Memory Tuning, just press and hold in the **[V/M]** key for 1/2 second, select a new memory (if desired), then press and hold in the **[V/M]** key for 1/2 second again.

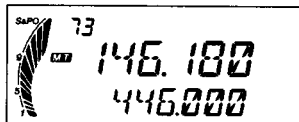

MASKING A MEMORY

There may be situations where you want to “Mask” memories so they are not visible during memory selection or scanning. For example, several memories used only in a city you visit infrequently may be stored, then “Masked” until you visit that city, at which time you can “Unmask” them for normal use.

1. Press and hold the **[V/M]** key for 1/2 second.
2. Rotate the **Main Dial** knob (or press the microphone’s **[UP]/[DWN]** buttons) to select the memory channel to be “Masked” from view.
3. Press the **[REV]** key momentarily. The display will revert to memory channel #1, and the previously-selected memory will now be “Masked.”
4. To unmask the hidden memory, repeat the above procedure: press and hold in the **[V/M]** key for 1/2 second, select the masked memory’s number, then press the **[REV]** key momentarily to restore the memory channel’s data.



If you over-write a “masked” memory channel, the original contents of the memory will be lost.

MEMORY OPERATION

TRANSFERRING MEMORY CHANNELS

There are 262 programmable memory channels in the **FT-7100M**. These consist of 120 regular memories and 11 special-purpose memories (L1 - L5, U1 - U5, and HOME) for each band. However, if you need more memories on a particular band, you can transfer (regular) memories from one group to another, as needed (such as VHF: 190 channels, UHF: 50 channels).

To transfer memory channels from one band to the other:

1. Press and hold in the **[BAND]** key while turning the transceiver on.
2. The display will show the present memory channel ratio. Rotate the **Main Dial** knob to select the memory channel ratio you need.
3. Press and hold in the **[BAND]** key for 1/2 second to save the new setting and exit to normal operation.

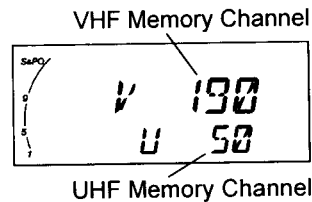

Previously-stored channel data is lost when performing this procedure.

MEMORY ONLY MODE

Once memory channel programming has been completed, you may place the radio in a "Memory Only" mode, whereby VFO operation is impossible. This may be particularly useful during public-service events where a number of operators may be using the radio for first time, and ultimate simplicity of channel selection is desired.

To place the radio into the Memory Only mode, turn the radio off. Now press and hold in the **[V/M]** key while turning the radio on.

To return to normal operation, repeat the above power-on procedure.

SCANNING FEATURES

SCANNING OPERATION

The **FT-7100M**'s microprocessor-based scanning feature allows quick scanning of the memory channels, or sweeping of a band, looking for activity.

Before activating the scanner, make sure that the **SQL** control is set to silence the background noise when no signal is present. If the noise is not squelched, the transceiver will "think" that it has found a signal, and will not scan.

Scanning may be started or stopped with the microphone's **[UP]** or **[DWN]** button.

The following techniques are used for scanning:

1. Pressing and holding in either the **[UP]** or **[DWN]** button for 1/2 second *in the VFO mode* will cause upward or downward *band scanning*, respectively, to begin.
2. Pressing and holding in either the **[UP]** or **[DWN]** button for 1/2 second in the *Memory mode* will cause *memory channel scanning* toward a higher- or lower-numbered memory channel, respectively.
3. Scanning pauses when a signal opens the squelch, and the decimal point on the display will blink. You can choose one of two scan-resume modes (described below).
4. To halt the scan manually, the easiest way is to push the **PTT** switch on the microphone momentarily (no transmission will occur while you are scanning).
5. The scan may also be halted manually by pressing the microphone's **[UP]/[DWN]** button, or the front panel's **[V/M]** key.

Scan-Resume Options

Two scan-resume modes are available on the **FT-7100M**:

- In the **BUSY** mode, the scanner will remain stopped for as long as there is a carrier present on the channel; after the carrier drops at the end of the other station's transmission, the scanner will resume.
- In the **TIME** mode, the scanner will halt for five seconds only, after which scanning will resume (whether or not the other station is still transmitting).

To change the scan-resume mode, use the following procedure:

1. Press and hold in the **[BAND]** key for 1/2 second to activate the "Menu" mode.
2. Rotate the **Main Dial** knob to select Menu # 25 (SCAN).
3. Press the **[BAND]** key momentarily to enable changing of this Menu item.
4. Rotate the **Main Dial** knob to select the desired scan-resume mode (**BUSY** or **TIME**).
5. Press and hold in the **[BAND]** key for 1/2 second to save the new setting and exit to normal operation.

SCANNING FEATURES

MEMORY SKIP SCANNING

When you have some continuously-active channels in memories, you may wish to skip them for scanning, but still have them available for manual selection using the **Main Dial**.

To mark a memory to be skipped during scanning, use the following procedure:

1. Recall the memory channel to be skipped.

Note: Memory Channel “1” may *not* be skipped.

2. Press and hold in the [TONE] key for 1/2 second. A small “▲” icon will appear to the bottom of the memory channel number, indicating it is to be ignored during scanning.
3. To re-enable a “skipped” memory channel, repeat the

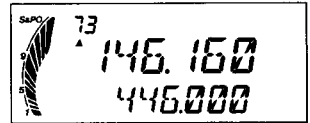

above procedure: recall the skipped memory channel using the **Main Dial**, then press and hold in the [TONE] key for 1/2 second to re-enable the channel.

Temporary Memory Skip

If the scanner repeatedly stops on a channel due to temporary noise or interference, you can temporarily mark it to be skipped (except for Memory Channel “1”). The channel will be skipped until you manually stop the scan (by pressing the **PTT** switch, for example).

To skip a channel temporarily, press the [TONE] key momentarily while the scanner has stopped on the channel to be skipped. The scanner will instantaneously resume, and that channel will not be scanned during this scanning session.

SCANNING FEATURES

PROGRAMMABLE BAND-SCAN LIMITS

This feature allows you to set sub-band limits for either scanning or manual VFO operation. For example, you might wish to set up a limit (in North America) of 144.300 MHz to 148.00 MHz so as to prevent encroachment into the SSB/CW “Weak Signal” portion of the band below 144.300 MHz. Here’s how to do this:

1. Set the radio to the VFO mode by pressing the **[V/M]** key, if necessary.
2. Using the techniques learned earlier, store (per above example) 144.300 MHz into Memory Channel “L1” (the “L” designates the Lower sub-band limit).
3. Likewise, store 148.000 MHz into Memory Channel “U1” (the “U” designates the Upper sub-band limit).
4. Switch to the Memory Recall mode by pressing the **[V/M]** key once, then recall Memory Channel “L1” or “U1.”
5. Press the **[MHz]** key momentarily; the “**MT**” icon will appear on the display.
6. You may now rotate the **Main Dial** knob, or begin scanning by press and holding in the microphone’s **[UP]/[DWN]** button for 1/2 second. The transceiver will behave as though it is in the standard VFO mode, but operation will be restricted to the range between Memory channels “L1” and “U1.”

Five pairs of Band Limit memories, labeled “L1/U1” through “L5/U5,” are available. You therefore can set a number of operating sub-bands, if you like.

SCANNING FEATURES

PRIORITY CHANNEL OPERATION

The Priority function allows automatic checking for activity on a designated "Priority" Memory channel every five second while operating on the VFO, a HOME channel, or another Memory channel.

VFO Priority

1. Recall the memory channel which you want to use as the "Priority" frequency.
2. Now set the **FT-7100M** for operation on any VFO frequency on the same band as the Priority frequency.
3. Press and hold in the **[REV]** key for 1/2 second to activate the VFO Priority mode; the "**PRP**" icon will appear on the display. The frequency display will remain on the VFO frequency, but every five seconds the **FT-7100M** will check the Priority Channel (designated memory channel) for activity.
4. Press the **[V/M]** key to disable the VFO Priority mode and exit to the VFO mode.

Memory Priority

1. Store the frequency you wish to use as the "Priority" channel into memory channel "1."
2. Now set the **FT-7100M** for operation on another memory channel on the same band as the Priority channel .
3. Press and hold in the **[REV]** key for 1/2 second to activate the Memory Priority mode; the "**PRP**" icon will appear on the display. The frequency display will remain on the current memory channel frequency, but every five seconds the **FT-7100M** will check the Priority channel (memory channel "1") for activity.
4. Press the **[V/M]** key to disable the Memory Priority mode and exit to the memory mode.

HOME Priority

1. Recall the memory channel which you wish to use as the "priority" frequency.
2. Now set the **FT-7100M** for operation on the HOME channel that is on the same band as the selected HOME channel.
3. Press and hold in the **[REV]** key for 1/2 second to activate the HOME Priority mode; the "**PRP**" icon will appear on the display. The frequency display will remain on the HOME channel frequency, but every five seconds the **FT-7100M** will check the Priority channel (memory channel) for activity.
4. Press the **[V/M]** key to disable the HOME Priority mode and exit to the HOME channel.

The Smart Search feature may be used to load - automatically with no operator intervention - a special bank of up to 50 memory channels (per band) based on activity. Smart Search will sweep either the entire band or the portion of the band within the Programmable Band-Scan Limits, and will load the Smart Search memory bank with the frequency data pertaining to those channels on which activity is found. The channels are loaded in the order in which they are encountered, not according to signal strength or by ascending frequency.

The Smart Search feature is especially useful when visiting a city for the first time, where you may be unfamiliar with the repeater frequencies used locally; Smart Search discovers where the local activity is to be found, and automatically loads those frequencies for you.

Smart Search operation is simple to activate:

1. Press and hold in the **[TONE]** key for 1/2 second.
2. The Smart Search process will now cause the radio to scan upward on the current band, loading channels on which it encounters a signal strong enough to open the squelch.
3. When 50 channels are loaded or the scanner reaches the band edge, the scanner will stop and the transceiver will revert to the starting frequency.
4. To recall the Smart Search Memories just stored, rotate the **Main Dial** knob.
5. Press the **[VM]** key momentarily to exit the Smart Search mode.

Note that these memories are so-called “soft” memories; they will be lost if you exit Smart Search to a VFO/Memory, or if you initiate a new Smart Search. Smart Search also does not store CTCSS or DCS information; if you cannot access a repeater found during Smart Search, you may need to investigate possible access tones.

ARTS: AUTO RANGE TRANSPONDER SYSTEM

This system uses DCS signaling to inform you when you and another ARTS-equipped station are within communications range. Both stations must first select DCS operation using the same DCS code.

Whenever you press the **PTT** switch, or every 30 seconds after ARTS is activated, your radio will transmit a (subaudible) DCS signal. If the other radio is in range, the beeper (if enabled) will sound and “ARTS IN” will appear on the display. Whether you talk or not, the radios will continue to poll each other every 30 seconds while ARTS is activated.

You can also have your radio transmit your callsign via CW every ten minutes, to comply with identification requirements.

If either station moves out range for more than one minute (two polls), your radio will sense that no signal has been received. A beep will sound, and the display will change to “ARTS OUT” (out of range). If you move back into range, your radio will again beep, and the display will change back “ARTS IN”.

During ARTS operation, the microprocessor makes it impossible to change the operating frequency or other settings; you must first terminate ARTS to resume normal operation. This is a safety feature to prevent accidental loss of contact due to channel change, etc.

Here is how to activate ARTS:

1. Press and hold in the [**BAND**] key for 1/2 second to activate the “Menu” mode.
2. Rotate the **Main Dial** knob to select Menu # 3 (ARTS).
3. Press the [**BAND**] key momentarily to enable changing of this Menu item.
4. Rotate the **Main Dial** knob to select the desired ARTS operating mode: “RANGE,” “ALL,” or “OFF.” The operating descriptions assume that both radios are set to “ALL.”
5. Press and hold in the [**BAND**] key for 1/2 second to save the new setting and exit. The display will now show “ARTS OUT.” After two pollings (one minute), if a response is not detected, “ARTS OUT” will appear continuously; otherwise “ARTS IN” will be displayed as long as both stations remain in range.
6. To cancel ARTS operation, select “OFF” in step 4 above.

ARTS Modes

RANGE: A high tone beep will sound when the transceiver first detects that you are within range, and a low beep will sound when the other station goes out of range.

ALL: A high tone beep will sound every time a polling transmission is received from the other station, and a low beep will sound once when the other station goes out of range.

OFF: ARTS operation is disabled.

ARTS: AUTO RANGE TRANSPONDER SYSTEM

CW ID (Morse Identifier) Set up

The ARTS feature includes a CW identifier, as mentioned previously. The radio can be instructed to send “**DE (your callsign) K**” in Morse code every nine minutes during ARTS operation. The callsign may contain up to 6 characters.

Here’s how to program the CW Ider:

1. Press and hold in the **[BAND]** key for 1/2 second to activate the “Menu” mode.
2. Rotate the **Main Dial** knob to select Menu # 6 (CWIDW).
3. Press the **[BAND]** key momentarily to enable programming of your callsign.
4. You will notice the first character’s entry slot blinking. While it is blinking, rotate the **Main Dial** knob to select the desired character, then press the **[LOW]** key to move on to the next character to the right.
5. Rotate the **Main Dial** knob to select the next number or letter, then press the **[LOW]** key to move on the next character.
6. You may move to the back character by pressing the **[BAND]** key momentarily. Press and hold the **[BAND]** key for 1/2 second to erase the characters at the right.
7. When the callsign is complete, press and hold in the **[BAND]** key for 1/2 second to save the CW ID entry and exit to normal operation.

To activate the CW Ider for use during ARTS operation:

1. Press and hold in the **[BAND]** key for 1/2 second to activate the “Menu” mode.
2. Rotate the **Main Dial** knob to select Menu #5 (CWID).
3. Press the **[BAND]** key momentarily to enable changing of this Menu item.
4. Rotate the **Main Dial** knob to change the display to “ON.”
5. Press and hold in the **[BAND]** key for 1/2 second to save the new setting and exit to normal operation.
6. To disable the CW Ider, select “OFF” in step 4 above.

MISCELLANEOUS SETTINGS

SUB-DISPLAY OPTIONS

The Sub-Display can be set to one of four modes using the Menu.

1. Press and hold in the **[BAND]** key for 1/2 second to activate the “Menu” mode.
2. Rotate the **Main Dial** knob to select Menu #11 (DISP).
3. Press the **[BAND]** key momentarily to enable changing of the Menu item.
4. Rotate the **Main Dial** knob to select the new setting. The options include:
 - DC IN: Displays and monitors the battery or DC power supply voltage.
 - CW ID: Displays the CW ID (your call sign).
 - FREQ: Displays the “sub” band frequency.
 - OFF: Turns off the Sub-Display.

Note: When this Menu selection is set to “OFF,” the sub band receiver will be disabled.

5. Press and hold in the **[BAND]** key for 1/2 second to save the new display configuration and exit to normal operation.

AUTOMATIC POWER-OFF

The “Automatic Power-Off” (APO) feature will turn the radio completely off after a user-defined period of **PTT** or key/button inactivity. If you do not press any front panel keys or buttons, do not rotate the **Main Dial** knob, do not use the microphone’s keys and buttons, do not transmit, and so long as the transceiver is not scanning or engaged in priority monitoring, the radio will shut itself off after the specified time period. This feature is useful in minimizing battery drain in a mobile installation if you forget to turn the transceiver off when you leave your vehicle.

To activate the APO feature:

1. Press and hold in the **[BAND]** key for 1/2 second to activate the “Menu” mode.
2. Rotate the **Main Dial** knob to select Menu #1 (APO).
3. Press the **[BAND]** key momentarily to enable changing of the Menu item.
4. Rotate the **Main Dial** knob to select the desired “switch-off” time (between 0.5 and 12 hours (0.5 hour steps), or OFF).
5. Press and hold in the **[BAND]** key for 1/2 second to save the new APO setting and exit to normal operation.

When the APO feature is activated, “**APO**” appears at the left of the frequency on the display, and a timer starts every time you press a key. If you don’t press the any keys until about three minutes before the end of the selected power-down period, *as long as you are not scanning or priority monitoring*, “**APO**” will begin blinking and an alert beeper will sound. If you don’t press a key in the next three minutes, the transceiver will turn itself off.

MISCELLANEOUS SETTINGS

PROGRAMMING THE MICROPHONE BUTTON FUNCTIONS

Default **FT-7100M** button functions have been assigned (at the factory) to the microphone's buttons*. These may be changed by the user, if you wish to define another function for a particular button or buttons

To change the assignment of a button's function:

1. Press and hold in the **[BAND]** key for 1/2 second to activate the "Menu" mode.
2. Rotate the **Main Dial** knob to select the Menu item corresponding to the button to be assigned a function (20: PG P1, 21: PG P2, 22: PG P3, or 23: PG P4).

MENU ITEM	MH-48A6J LABEL	MH-42B6JS LABEL
20: PG P1	[P1] button	[ACC] button
21: PG P2	[P2] button	[P] button
22: PG P3	[P3] button	[P1] button
23: PG P4	[P4] button	[P2] button
3. Press the **[BAND]** key momentarily to enable changing of the selected Menu item.
4. Rotate the **Main Dial** knob to select the function you wish to assign to the button you selected in the previous step. The available choices are:
 - SQL OFF: Disables (opens) the Noise and Tone Squelch.
 - TCALL: Activates 1750 Hz Tone Burst.
 - RPTR: Selects Repeater Shift Direction.
 - PRI: Activates Priority Channel monitoring.
 - LOW: Selects Power Output Level.
 - TONE: Selects CTCSS or DCS mode and tone/code.
 - MHz: Enables selection of the "MHz" digit of the frequency.
 - REV: Reverses Repeater Uplink/Downlink frequencies.
 - HOME: Switches frequency to the "Home" channel.
 - BAND: Selects "main" band of operation: VHF or UHF.
 - VFO/MR: Switches frequency control between VFO and Memory.
5. Press and hold in the **[BAND]** key for 1/2 second to save the new setting(s) and exit to normal operation.

*: **MH-48A6J**: [P1], [P2], [P3], and [P4] buttons.

MH-42B6JS: [ACC], [P], [P1], and [P2] buttons.

MISCELLANEOUS SETTINGS

DCS CODE INVERSION

The DCS system was first introduced in the commercial LMR (Land Mobile Radio) service, where it is now in widespread use.

DCS uses a codeword consisting of a 23-bit frame, transmitted (subaudibly) at a data rate of 134.4 bps (bit/sec). Occasionally, signal inversion can result in the complement of a code being sent or received. This prevents the receiver squelch from opening with DCS enabled, as the decoded bit sequence would not match that selected for operation. Typical situations that might cause inversion to occur are:

- Connection of an external receiver preamplifier.
- Operating through a repeater.
- Connection of an external linear amplifier.

Note that code inversion does not mean that any of the above listed equipment is defective! In certain amplifier configurations, the output signal (phase) is inverted from the input. Small signal or power amplifiers having an odd number (1, 3, 5, etc.) of amplification stages may result in inversion of a transmitted or received DCS code.

While under most circumstances this should not occur (amplifier designs and industry standards take this into account), if you find that your receiver squelch does not open when both you and the other station are using a common DCS code, you or the other station (but not both) can try the following:

1. Press and hold in the **[BAND]** key for 1/2 second to activate the “Menu” mode.
2. Rotate the **Main Dial** knob to select Menu #10 (DCSNR)
3. Press the **[BAND]** key momentarily to enable changing of the Menu item.
4. Rotate the **Main Dial** knob to select one of the following modes:
 - TRX N: Encoder Normal; Decoder Normal
 - RX R: Encoder Normal; Decoder Reverse (Inverted)
 - TX R: Encoder Reverse (Inverted); Decoder Normal
 - TRX R: Encoder Reverse (Inverted); Decoder Reverse (Inverted)
5. Press and hold in the **[BAND]** key for 1/2 second to save the new setting and exit to normal operation.

MISCELLANEOUS SETTINGS

EXTERNAL SPEAKER SELECTION

You can select the audio output configuration for the speakers when an external speaker is connected to the **EXT SP** jack on the rear panel.

To select the speaker to be used on a particular band:

1. Press and hold in the [**BAND**] key for 1/2 second to activate the “Menu” mode.
2. Rotate the **Main Dial** knob to select Menu #28 (SPCNT).
3. Press the [**BAND**] key momentarily to enable changing of this Menu item.
4. Rotate the **Main Dial** knob to select the new setting. The options include:

BAND A: Directs VHF band audio to the external speaker, and UHF band audio to the internal speaker. During V-V operation (VHF) audio from the upper frequency display field on the LCD is sent to the external speaker, while (VHF) audio from the lower frequency display field on the LCD is sent to the internal speaker. Conversely, during U-U operation, upper-display-field UHF audio is sent to the *internal* speaker, and lower-display-field UHF audio is sent to the *external* speaker.

BAND B: Directs UHF band audio to the external speaker, and VHF band audio to the internal speaker. During V-V operation (VHF) audio from the upper frequency display field on the LCD is sent to the internal speaker, while (VHF) audio from the lower frequency display field on the LCD is sent to the external speaker. Conversely, during U-U operation, upper-display-field UHF audio is sent to the *external* speaker, and lower-display-field UHF audio is sent to the *internal* speaker.

BOTH: Outputs both VHF and UHF band audio from the external speaker, and turns off the internal speaker.

OFF: Turns off the external speaker, and outputs both VHF and UHF band audio from the internal speaker.

5. Press and hold in the [**BAND**] key for 1/2 second to save the new configuration and exit to normal operation.

Some or all transceiver settings can be reset to their factory-default states using one of the following power-on routines:

MICROPROCESSOR RESET PROCEDURES

Reset for All Memories

Press and hold in the [V/M] and [REV] keys while turning the transceiver on.

Reset for Menu Settings (except following menu)

Press and hold in the [LOW] and [REV] keys while turning the transceiver on.

Menu #8 (DCS C), 19 (PCKT), 26 (SHIFT), 27 (STEP), 29 (TONEF)

CPU Master Reset for All Memories and Menu Settings

Press and hold in the [V/M], [MHz], and [REV] keys while turning the transceiver on.

CLONING

You can transfer all data stored in one **FT-7100M** to another **FT-7100M** by utilizing the handy “Cloning” feature. This requires a user-constructed Cloning cable which connects the **DATA** jacks on the two transceivers, as shown below.

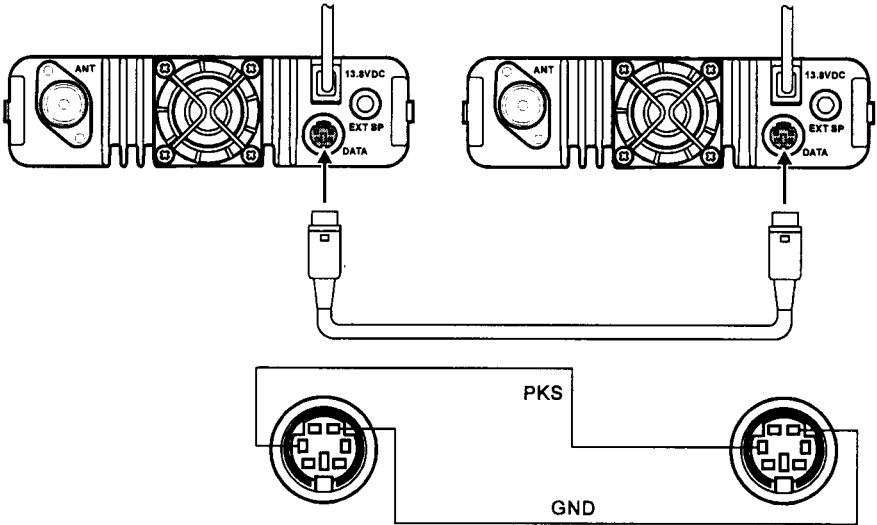

To clone from one transceiver to another, use the following procedure:

1. Insert the Clone Cable into the **DATA** jack of each transceiver.
2. Turn both transceivers off, then press and hold in the **[REV]** and **[TONE]** keys (on each radio) while turning the power on again.
3. On the “*destination*” radio, press the **[REV]** key. The “CLONE RX” indicator will appear on the display.
4. Now, on the “*source*” radio, press the **[TONE]** key. The “CLONE TX” indicator will appear on the display, and the cloning data transfer will immediately begin.
5. If there is a problem during the cloning process, “ERROR” will be displayed. Check your cable connections, and try again.
6. If cloning was successful, the “CLONE RX” and “CLONE TX” indicator will disappear.
7. Turn both transceivers off, then remove the Clone Cable. Channel and operating data for both radios are now identical. They both may be turned on now for normal operation.

MENU SYSTEM

The **FT-7100M**'s Menu System allows a number of transceiver operating parameters to be custom-configured for your operating requirements.

The Menu is easy to active and set, using the following basic procedure:

1. Press and hold in the [**BAND**] key for 1/2 second to activate the “Menu” mode.
2. Rotate the **Main Dial** knob to select the Menu item to be adjusted.
3. Press the [**BAND**] key momentarily to enable changing of the selected Menu item.
4. Rotate the **Main Dial** knob to adjust or select the desired parameter of the selected Menu item.
5. After completing your adjustment(s), press and hold in the [**BAND**] key for 1/2 second to save the new setting(s) and exit to normal operation.

MENU SYSTEM

Item #	Menu Item	Function	Available Values	Default
1	APO	Enables/disables the Automatic Power Off feature	OFF/0.5 ~ 12.0 hours	OFF
2	ARS	Enables/disables the Automatic Repeater Shift function	ON/OFF	ON
3	ARTS	Selects the ARTS mode	RANGE/ALL/OFF	OFF
4	BEEP	Enables/disables the key/button beeper	ON/OFF	ON
5	CWD	Enables/disables the CW IDer during ARTS operation	ON/OFF	OFF
6	CWDW	Programming a callsign into the CW IDer	-	-
7	DIM	Setting the front panel display's illumination level	OFF/DIM 1 ~ DIM 7	DIM 1
8	DCSC	Setting the DCS code number	104 standard DCS codes	023
9	DCS S	Activates the DCS Code Search Scanner	-	-
10	DCSNR	Selects "Normal" or "Inverted" DCS coding	TRX N/RX R/TX R/TRX R	TRX N
11	DISP	Selects the "sub" band display format	FREQ/OFF/DCIN/CWID	FREQ
12	DTMFD	Setting the DTMF Autodialer delay time	50/250/450/750/1000 ms	450 ms
13	DTMFS	Setting the DTMF Autodialer sending speed	50/75/100 ms	50 ms
14	DTMFW	Loading of DTMF Autodial memory register(s)	-	-
15	LOCK	Enables/disables the key/button lock	ON/OFF	OFF
16	LOCKT	Enables/disables the PTT switch lock	BAND A/BAND B/BOTH/OFF	OFF
17	MIC	Selects the Microphone type to be used	MH-42/MH-48	×
18	MUTE	Reduces the audio level on the sub receiver when the main receiver is active	AUTO/OFF	OFF
19	PCKT	Setts the transceiver's circuitry for the Packet baud rate to be used	1200/9600 bps	1200 bps
20	PGP1	Programming the microphone's [P1]/[ACC] button assignment	SQL OFF, TCALL, RPTR, PRI, LOW, TONE, MHZ, REV, HOME, BAND, VFO/MR	×
21	PGP2	Programming the microphone's [P2]/[P] button assignment		VFO/MR
22	PGP3	Programming the microphone's [P3]/[P1] button assignment		TONE
23	PGP4	Programming the microphone's [P4]/[P2] button assignment		LOW
24	RFSQL	Adjusts the RF SQL threshold level	S-1/S-5/S-9/S-FULL/OFF	OFF
25	SCAN	Selects the Scan-Resume mode	BUSY/TIME	BUSY
26	SHIFT	Sets the magnitude of the Repeater Shift	0.00 ~ 99.50 MHz	×
27	STEP	Setting the synthesizer steps	5.0/10.0/12.5/15.0/20.0/ 25.0/50.0 kHz	×
28	SPCNT	Defining the audio path to the external speaker (when used)	BAND A/BAND B/BOTH/OFF	BOTH
29	TONEF	Setting the CTCSS Tone Frequency	50 standard CTCSS Tones	100 Hz
30	TSRCH	Activates the CTCSS Tone Search Scanner	-	-
31	TOT	Sets the Time-Out Timer	OFF/1 ~ 30 minutes	6 minutes
32	TXNAR	Reducing the MIC Gain (and Deviation)	ON/OFF	OFF
33	VFOTR	Enables/disables the VFO Tracking feature	ON/OFF	OFF
34	AM	Selects the receiving mode (VHF band)	AUTO/INH/AM	AUTO

×: Depends on transceiver version

MENU SYSTEM

MENU SELECTION DETAILS

Menu Item 1 [APO]

Function: Enables/disables the Automatic Power Off feature.

Available Values: 0.5 ~ 12.0 hours (0.5 hour steps), or OFF

Default Setting: OFF

Menu Item 2 [ARS]

Function: Enables/disables the Automatic Repeater Shift function.

Available Values: ON/OFF

Default Setting: ON

Note: This Menu item can be set independently for each band.

Menu Item 3 [ARTS]

Function: Selects the ARTS mode.

Available Values: RANGE/ALL/OFF

Default Setting: OFF

Note: This Menu item can be set independently for each band.

Menu Item 4 [BEEP]

Function: Enables/disables the key/button beeper.

Available Values: ON/OFF

Default Setting: ON

Menu Item 5 [CWID]

Function: Enables/disables the CW IDer during ARTS operation.

Available Values: ON/OFF

Default Setting: OFF

Menu Item 6 [CWIDW]

Function: Programming a callsign into the CW IDer.

Menu Item 7 [DIM]

Function: Setting the front panel display's illumination level.

Available Values: DIM1 ~ DIM7, or OFF

Default Setting: DIM1 (Brightest illumination)

MENU SELECTION DETAILS

Menu Item 8 [DCS C]

Function: Setting the DCS code number.

Available Values: 104 standard DCS codes

Default Setting: 023

Note: This Menu item can be set independently for each band, and independently in each memory.

Menu Item 9 [DCS S]

Function: Activates the DCS Code Search Scanner.

DCS CODE										
023	025	026	031	032	036	043	047	051	053	
054	065	071	072	073	074	114	115	116	122	
125	131	132	134	143	145	152	155	156	162	
165	172	174	205	212	223	225	228	243	244	
245	246	251	252	255	261	263	265	266	271	
274	306	311	315	325	331	332	343	346	351	
356	364	365	371	411	412	413	423	431	432	
445	446	452	454	455	462	464	465	466	503	
506	516	523	526	532	546	565	606	612	624	
627	631	632	654	662	664	703	712	723	731	
732	734	743	754	-	-	-	-	-	-	

Menu Item 10 [DCSNR]

Function: Selects “Normal” or “Inverted” DCS coding.

Available Values: TRX N/RX R/TX R/TRX R

Default Setting: TRX N

Note 1: This Menu item can be set independently for each band.

Note 2: “N” is “normal,” “R” is “inverted.”

Menu Item 11 [DISP]

Function: Selects the “sub” band display format.

Available Values: FREQ/OFF/DC IN/CW ID

Default Setting: FREQ

FREQ: Displays the “sub” band frequency.

OFF: No display.

DC IN: Displays the DC supply voltage.

CW ID: Displays the CW ID while the ATRS feature is activated.

Note: When this Menu selection is set to “OFF,” the sub band receiver will be disabled.

Menu Item 12 [DTMFD]

Function: Setting the DTMF Autodialer delay time.

Available Values: 50/250/450/750/1000 ms

Default Setting: 450 ms

Menu Item 13 [DTMFS]

Function: Setting the DTMF Autodialer sending speed.

Available Values: 50/75/100 ms

Default Setting: 50 ms (High Speed)

MENU SYSTEM

MENU SELECTION DETAILS

Menu Item 14 [DTMFW]

Function: Loading of DTMF Autodial memory register(s).

Menu Item 15 [LOCK]

Function: Enables/disables the key/button lock.

Available Values: ON/OFF

Default Setting: OFF

Menu Item 16 [LOCKT]

Function: Enables/disables the PTT switch lock.

Available Values: BAND A/BAND B/BOTH/OFF

Default Setting: OFF

Note: “BAND A” is “VHF,” “BAND B” is “UHF.”

Menu Item 17 [MIC]

Function: Selects the Microphone type to be used.

Available Values: MH-42/MH-48

Default Setting: Depends on transceiver version.

Menu Item 18 [MUTE]

Function: Reduces the audio level on the sub receiver when the main receiver is active.

Available Values: AUTO/OFF

Default Setting: OFF

Menu Item 19 [PCKT]

Function: Sets the transceiver’s circuitry for the Packet baud rate to be used.

Available Values: 1200/9600 bps

Default Setting: 1200 bps

Note: This Menu item can be set independently for each band.

Menu Item 20 [PG P1]

Function: Programming the microphone’s [P1]/[ACC] button assignment.

Available Values: SQL OFF, TCALL, RPTR, PRI, LOW, TONE, MHz, REV, HOME, BAND, VFO/MR

Default Setting: USA version; BAND, European version; TCALL

Note: [P1] button for **MH-48A6J**, [ACC] button for **MH-42B6SJ**

MENU SELECTION DETAILS

Menu Item 21 [PG P2]

Function: Programming the microphone's [P2]/[P] button assignment.

Available Values: SQL OFF, TCALL, RPTR, PRI, LOW, TONE, MHz, REV, HOME, BAND, VFO/MR

Default Setting: VFO/MR

Note: [P2] button for **MH-48A6J**, [P] button for **MH-42B6SJ**

Menu Item 1 [PG P3]

Function: Programming the microphone's [P3]/[P1] button assignment.

Available Values: SQL OFF, TCALL, RPTR, PRI, LOW, TONE, MHz, REV, HOME, BAND, VFO/MR

Default Setting: TONE

Note: [P3] button for **MH-48A6J**, [P1] button for **MH-42B6SJ**

Menu Item 23 [PG P4]

Function: Programming the microphone's [P4]/[P2] button assignment.

Available Values: SQL OFF, TCALL, RPTR, PRI, LOW, TONE, MHz, REV, HOME, BAND, VFO/MR

Default Setting: LOW

Note: [P4] button for **MH-48A6J**, [P2] button for **MH-42B6SJ**

Menu Item 24 [RFSQL]

Function: Adjusts the RF SQL threshold level.

Available Values: S-1/S-5/S-9/S-FULL/OFF

Default Setting: OFF

Note: This Menu item can be set independently for each band.

Menu Item 25 [SCAN]

Function: Selects the Scan-Resume mode.

Available Values: BUSY/TIME

Default Setting: BUSY

Note: This Menu item can be set independently for each band.

Menu Item 26 [SHIFT]

Function: Sets the magnitude of the Repeater Shift.

Available Values: 0.00 ~ 99.50 MHz (50 kHz step)

Default Setting: Depends on transceiver version.

Note: This Menu item can be set independently for each band.

MENU SYSTEM

MENU SELECTION DETAILS

Menu Item 27 [STEP]

Function: Setting the synthesizer steps.

Available Values: 5.0/10.0/12.5/15.0/20.0/25.0/50.0 kHz

Default Setting: Depends on transceiver version.

Note: This Menu item can be set independently for each band.

Menu Item 28 [SPCNT]

Function: Defining the audio path to the external speaker (when used).

Available Values: BAND A/BAND B/BOTH/OFF

Default Setting: BOTH

Note: BAND A: VHF Audio

During V-V operatin, audio from “upper” VHF frequency on the LCD.

During U-U operatin, audio from “lower” UHF frequency on the LCD.

BANDB: UHF Audio

During V-V operatin, audio from “lower” VHF frequency on the LCD.

During U-U operatin, audio from “upper” UHF frequency on the LCD.

BOTH: VHF and UHF audio are both routed to external speaker (internal speaker is off)

OFF: All audio is routed to internal speaker (external speaker is off).

Menu Item 29 [TONEF]

Function: Setting the CTCSS Tone Frequency.

Available Values: 50 Standard CTCSS Tones

Default Setting: 100 Hz

Note: This Menu item can be set independently for each band, and independently in each memory.

Menu Item 30 [TSRCH]

Function: Activates the CTCSS Tone Search Scanner.

CTCSS TONE FREQUENCY (Hz)						
67.0	69.3	71.9	74.4	77.0	79.7	
82.5	85.4	88.5	91.5	94.8	97.4	
100.0	103.5	107.2	110.9	114.8	118.8	
123.0	127.3	131.8	136.5	141.3	146.2	
151.4	156.7	159.8	162.2	165.5	167.9	
171.3	173.8	177.3	179.9	183.5	186.2	
189.9	192.8	196.6	199.5	203.5	206.5	
210.7	218.1	225.7	229.1	233.6	241.8	
250.3	254.1	-	-	-	-	

Menu Item 31 [TOT]

Function: Sets the Time-Out Timer.

Available Values: 1 ~ 30 minutes, or OFF

Default Setting: 6 minutes

MENU SELECTION DETAILS

Menu Item 32 [TXNAR]

Function: Reducing the MIC Gain (and Deviation)

Available Values: ON/OFF

Default Setting: OFF (Normal Deviation)

Note: This Menu item can be set independently for each band.

Menu Item 33 [VFOTR]

Function: Enables/disables the VFO Tracking feature.

Available Values: ON/OFF

Default Setting: OFF

Menu Item 34 [AM]

Function: Selects the receiving mode on the VHF band.

Available Values: AUTO/INH/AM

Default Setting: AUTO (AM in Aeronautical Bands, FM elsewhere)